

Partdrawing for GA013GZ - Haakse slijper

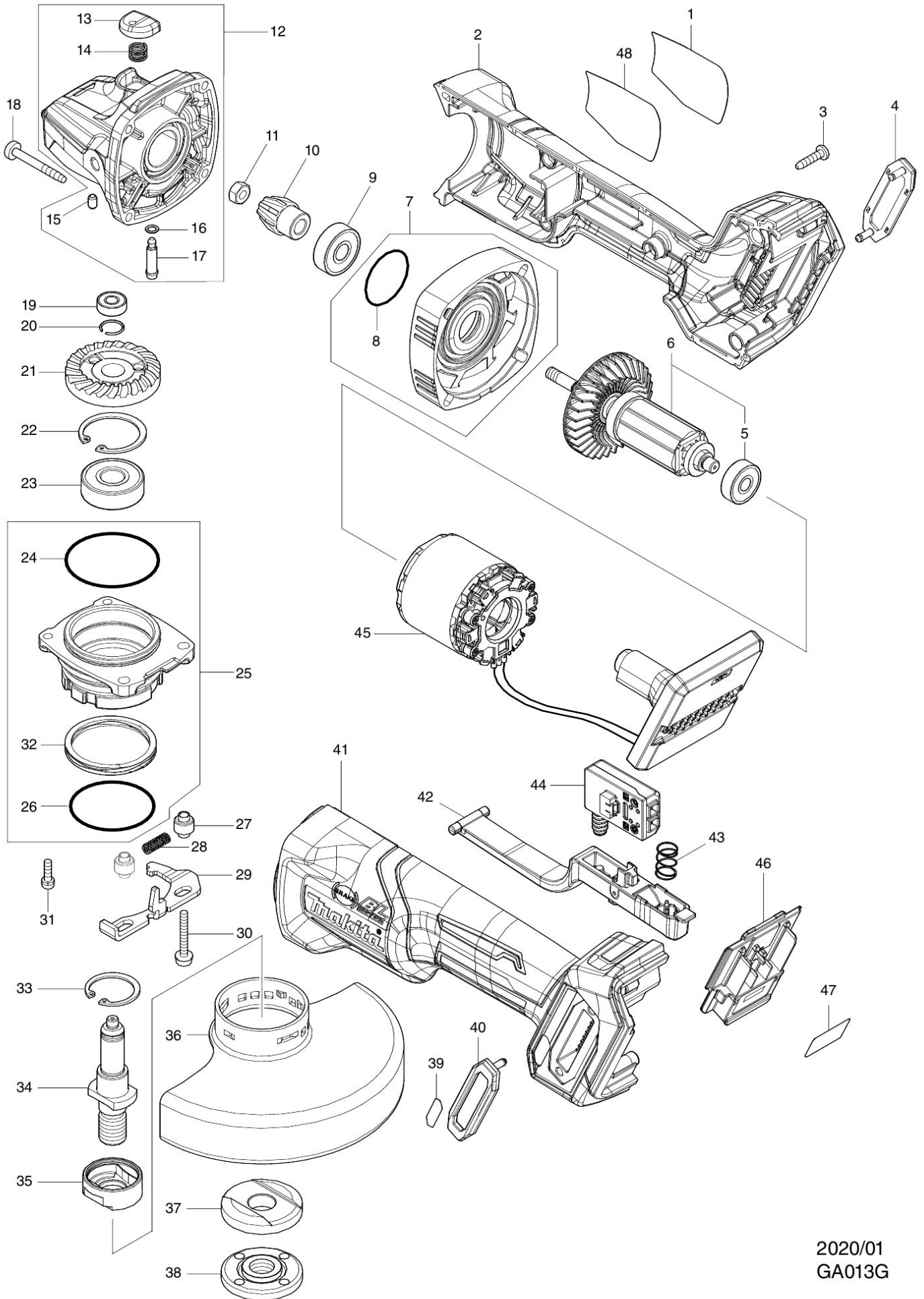

2020/01
GA013G